

# Battery Holders

## Surface Mounting Technology (SMT)



### Horizontal mounting

#### Features

- Easy and fast replacement of the battery
- Designed for automatic pick&place mounting
- Safe retention of coin cell
- Automated battery mounting possible
- Clear separation of connections
- Protection against short-circuits
- Protection against inverse polarity (polarized)
- Protection against leak currents
- Robust design
- Suitable for reflow-soldering

#### Specifications

- Holder material: heat-resistant, glass fibre filled LCP
- Flammability rating UL 94 V-0
- Battery contacts: spring stainless steel AISI 301, nickel-plated throughout. Solder area tin-plated throughout, min. thickness 5  $\mu\text{m}$ .
- Contact resistance between contacts and the cell is less than 100  $\text{m}\Omega$  (measured through AC 1kHz; depending on the case material of the cell).
-  UL recognition, file E218732
- Operating temperature range:  $-40/+100^\circ\text{C}$

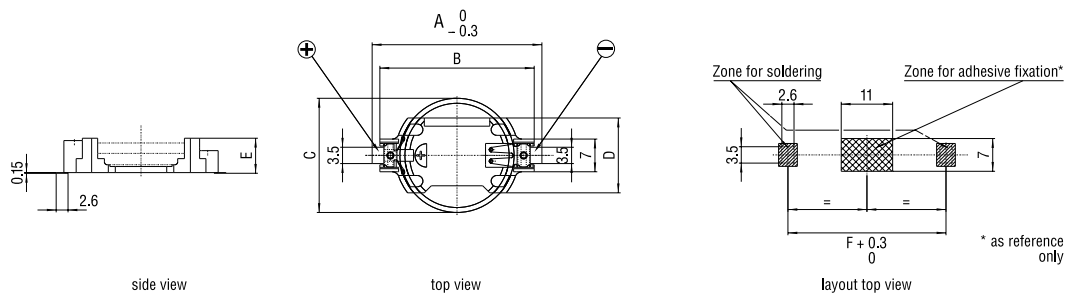
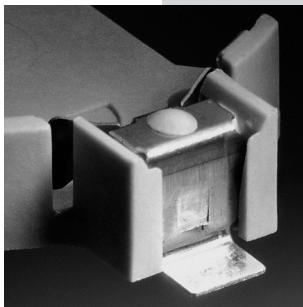

### Dimensions

Model	For use with Renata cell	Dimensions (mm)						Weight (g)	Part.No.*
		A	B	C	D	E	F		
SMTU357-LF	357 (SR44W)	23.3	19.9	11.6	12.0	7.55	20.7	0.85	701132
SMTU1220-LF	CR1220	23.7	20.3	12.5	12.7	4.8	21.1	0.80	701114
SMTU1225-LF	CR1225	23.7	20.3	12.5	12.7	4.8	21.1	0.70	701115
SMTU1632-LF	CR1632	27.7	24.3	16.0	14.5	5.4	25.1	0.80	701130
SMTU2032-LF	CR2032	32.0	28.5	20.0	16.1	5.4	29.4	0.95	701116
SMTU2430-LF	CR2430	36.4	33.0	24.5	16.1	4.9	33.8	1.05	701117
SMTU2450N-LF	CR2450N <sup>1)</sup>	36.4	33.0	24.5	16.1	7.5	33.8	1.45	701118
SMTU2477N-LF	CR2477N	36.4	33.0	24.5	16.1	10.3	33.8	1.65	701119
SM2X2016-LF	CR2016	32.0	28.5	20.0	16.1	5.4	29.4	0.95	701113

\*Packaging: Industrial Bulk (B-Trays)

1) Not suitable for CR2450HT

# Battery Holders

## Through-hole mounting

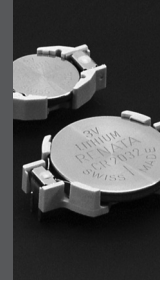

renata  
batteries

### Horizontal mounting

#### Features

- Easy and fast replacement of the battery
- Designed for automatic pick&place mounting
- Safe retention of coin cell
- Automated battery mounting possible
- Clear separation of connections
- Protection against short-circuits
- Protection against inverse polarity (polarized)
- Protection against leak currents
- Robust design
- Suitable for wave-soldering

#### Specifications

- Holder material: heat-resistant, glass fibre filled LCP
- Flammability rating UL 94 V-0
- Battery contacts: spring stainless steel AISI 301, nickel-plated throughout. Solder area tin-plated throughout, min. thickness 5  $\mu\text{m}$ .
- Contact resistance between contacts and the cell is less than 100  $\text{m}\Omega$  (measured through AC 1kHz; depending on the case material of the cell).
-  UL recognition, file E218732
- Operating temperature range:  $-40/+100^{\circ}\text{C}$

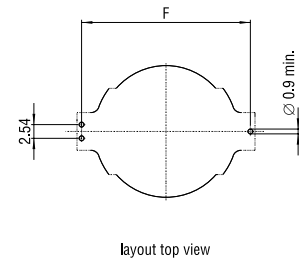
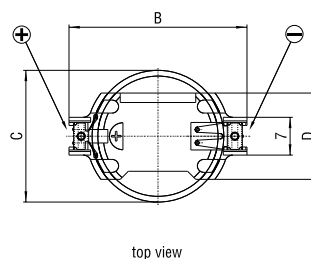
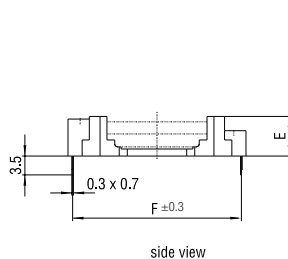
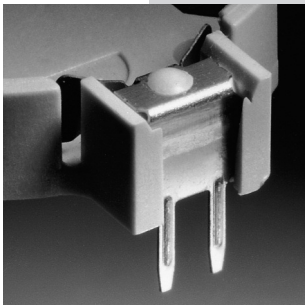

### Dimensions

Model	For use with Renata cell	Dimensions (mm)					Weight (g)	Part.No.*
		B	C	D	E	F		
HU357-LF	357 (SR44W)	19.9	11.6	12.0	7.4	18.65	0.84	701133
HU1225-LF	CR1225	20.3	12.5	12.7	4.5	19.1	0.70	701105
HU1632-LF	CR1632	24.3	16.0	14.5	5.2	23.0	0.80	701131
HU2032-LF	CR2032	28.5	20.0	16.1	5.2	27.2	0.95	701106
HU2430-LF	CR2430	33.0	24.5	16.1	4.7	31.7	1.05	701107
HU2450N-LF	CR2450N <sup>1)</sup>	33.0	24.5	16.1	7.3	31.75	1.45	701108
HU2477N-LF	CR2477N	33.0	24.5	16.1	10.1	31.8	1.65	701109

\*Packaging: Industrial Bulk (IB-Trays)

1) Not suitable for CR2450HT

# Battery Holders

## Through-hole mounting



### Vertical mounting

VBH2032-1 - Vertical battery holder for Renata coin cell CR2032 / CR2032MFR

#### Features

- Small PCB footprint
- Easy and fast replacement of the battery
- Safe retention of coin cell
- Protection against short-circuits
- Protection against inverse polarity (polarized)
- Protection against leak currents
- Robust design
- Suitable for wave-soldering

#### Specifications

- Holder material: polyamide
- Flammability rating UL 94 V-0
- Battery contacts: spring stainless steel AISI 301, nickel-plated throughout.
-  UL recognition, file E218732
- Operating temperature range: -40/+85°C

### Dimensions (mm)

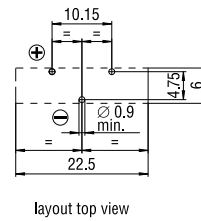
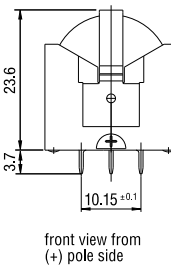
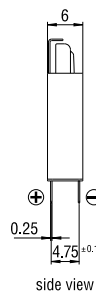
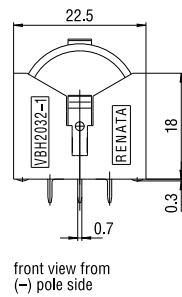
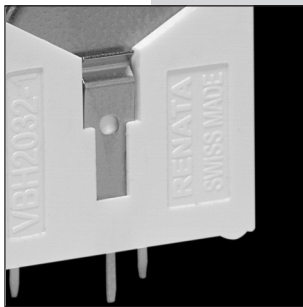

Model	For use with Renata cell	Weight (g)	Part. No.*
VBH2032-1	CR2032	1.6	700579

\*Packaging: Industrial Bulk (IB-Trays)

# Battery Holders

Through-hole mounting with positioning pins



Battery holders for CR2450N or CR2477N  
Vertical and horizontal versions

## Features

- Easy and fast replacement of the battery
- Snap-on fixing for coin cells
- Safe retention of coin cell
- Automated battery mounting possible
- Clear separation of connections
- Protection against short-circuits
- Protection against inverse polarity
- Protection against leak currents
- Robust design
- Easy and safe PCB mounting due to additional positioning pins
- Suitable for wave-soldering

## Specifications

- Holder material: polyamide
- Flammability rating UL 94 V-2
- Battery contacts: Nickel 99.6 DIN 17740
- Contact resistance between contacts and the cell is less than 100 mΩ (measured through AC 1kHz).
- Solder and positioning pins tin plated through-out, min. thickness 5 μm.
- UL recognition, file E218732
- Operating temperature range: -40/+85°C

### NH5077-LF Vertical version

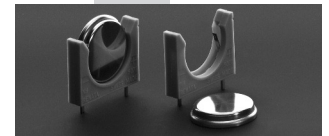
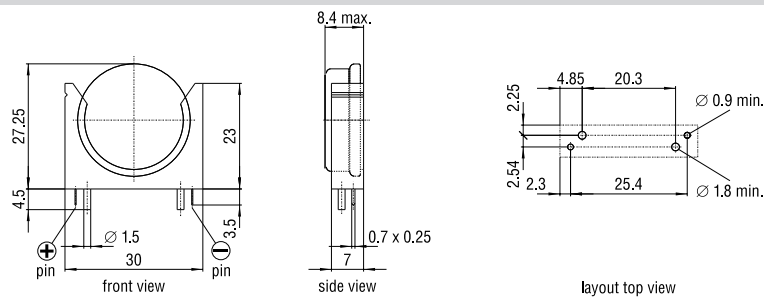
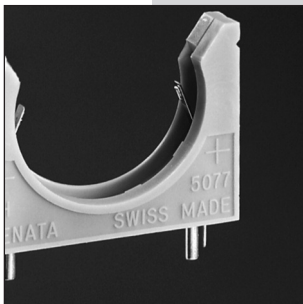

### NL5077-LF Horizontal version

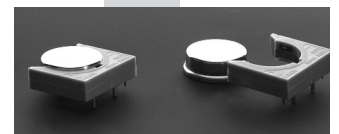
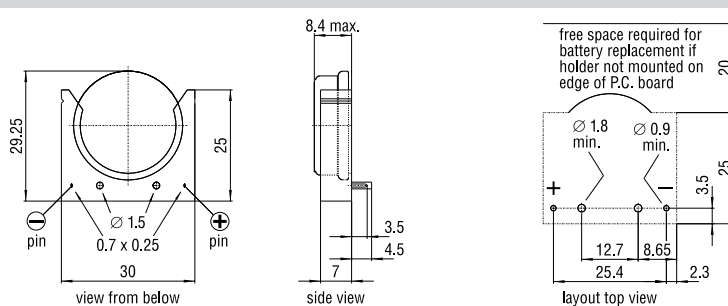
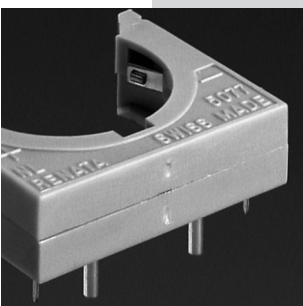

Model	For use with Renata cell	Weight (g)	Part.No.*
NH5077-LF	CR2450N <sup>1)</sup> , CR2477N	2.4	701111
NL5077-LF	CR2450N <sup>1)</sup> , CR2477N	2.9	701112

\*Packaging: Industrial Bulk (IB-Trays)

1) Not suitable for CR2450HT

# Battery Holders

## Packaging options

### Battery holders can be supplied in different packaging

#### Industrial Bulk multi-cell trays

Packaging Code: **IB**

Industrial Bulk packaging is the standard packaging for manufacturers.

The number of battery holders per tray depends on the respective model. So does the number of trays per shrink pack.

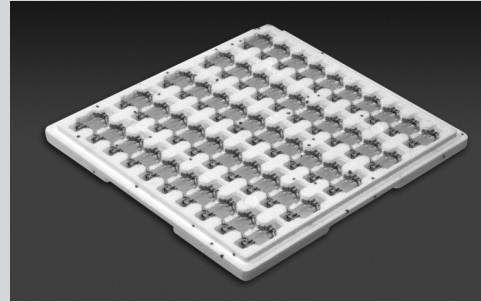

#### Tape&Reel packaging

Packaging Code: **TR**

For SMT-battery holders there is a Tape&Reel packaging solution available.

Tape&Reel packaging is ideal for high-speed, automated manufacturing lines.

The number of battery holders per reel depends on the respective model.

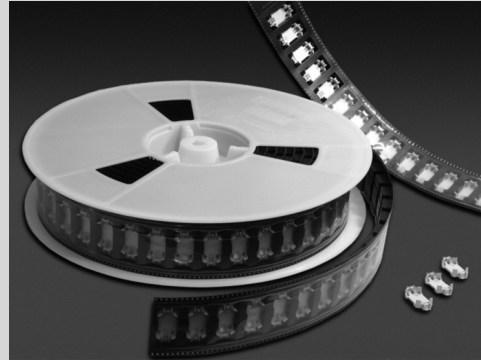

#### Quantity per reel:

Model	Quantity per Reel	Part.No.*
SMTU1225-LF TR	750 pieces	701230
SMTU1632-LF TR	520 pieces	701231
SMTU2032-LF TR	485 pieces	701232
SMTU2430-LF TR	490 pieces	701233
SMTU2450N-LF TR	350 pieces	701234
SMTU2477N-LF TR	250 pieces	701235
SM2X2016-LF TR	485 pieces	701236

\*Packaging: Tape&Reel (TR)